



CE

Bistable switches

Bistable switches

Bistable switches are switching devices with two stable states for switching of all kind of electric loads. When the switch is not initiated electrically or actuated manually, remains stable in its operating position and will change its operating position on initiation or actuation.



Bistable switches are switching devices without power consumption in operating switch-on position and very small power consumption per pole. On a very effective way helps to reduce greenhouse gas emissions of CO₂.

For remote switching

- Lights and lighting
- Electric heating
- Electric drives
- Intelligent installations

Advanced operation

- Impulse control
- Manual control

Other benefits

- Small switch on coil consumption
- No hold coil consumption
- Wide application
- Mounting on 35 mm rail
- Sealing terminal covers
- Disconnection of remote control by selector switch for maintenance operation
- All control voltages from 8 V till 240 V are possible

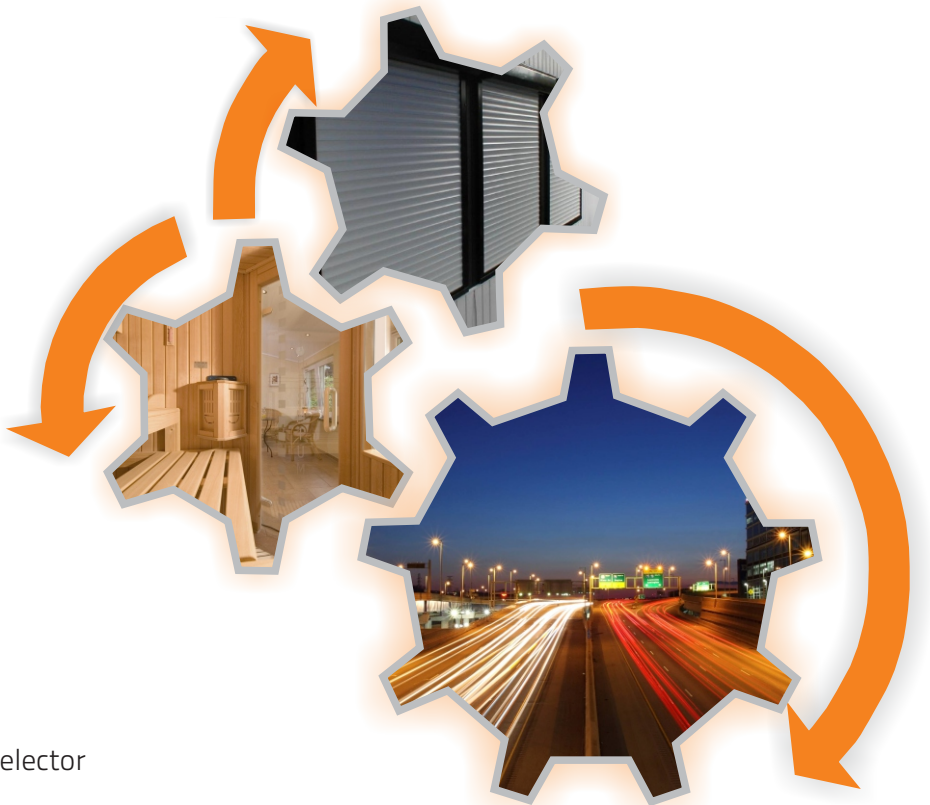

Bistable switches up to 32 A	page 2
Bistable switches up to 80 A	page 5
Bistable Switches Extended with a Communications	page 6
Accessories	page 8





Ordering data	page 4
Technical characteristics	page 11
Dimensions	page 21

Bistable Switches

up to 32 A

cos φ = 0.6 acc. to IEC/EN 60669-2-2 (2-pole, 1 module)

AC

Type	Rated current I _n	Control voltage at 50 Hz	Wiring diagram	Ordering No.	Weight (g)	Packaging (pcs)
BI216-20	16 A	230 V		30.070.278	135	8
BI216-20	16 A	24 V		30.070.279	135	8
BI220-20	20 A	230 V		30.070.024	135	8
BI220-20	20 A	24 V		30.070.091	135	8
BI225-20	25 A	230 V		30.070.059	135	8
BI225-20	25 A	24 V		30.070.179	135	8
BI232-20	32 A	230 V		30.070.025	135	8
BI232-20	32 A	24 V		30.070.071	135	8
BI216-11	16 A	230 V		30.070.276	135	8
BI216-11	16 A	24 V		30.070.277	135	8
BI220-11	20 A	230 V		30.070.028	135	8
BI220-11	20 A	24 V		30.070.074	135	8
BI225-11	25 A	230 V		30.070.180	135	8
BI225-11	25 A	24 V		30.070.181	135	8
BI232-11	32 A	230 V		30.070.029	135	8
BI232-11	32 A	24 V		30.070.054	135	8
BI216-1C	16 A	230 V		30.070.274	130	8
BI216-1C	16 A	24 V		30.070.275	130	8
BI220-1C	20 A	230 V		30.070.182	130	8
BI220-1C	20 A	24 V		30.070.183	130	8
BI225-1C	25 A	230 V		30.070.063	130	8
BI225-1C	25 A	24 V		30.070.064	130	8
BI232-1C	32 A	230 V		30.070.184	130	8
BI232-1C	32 A	24 V		30.070.185	130	8
BI216-10	16 A	230 V		30.070.272	130	8
BI216-10	16 A	24 V		30.070.273	130	8
BI220-10	20 A	230 V		30.070.056	130	8
BI220-10	20 A	24 V		30.070.090	130	8
BI225-10	25 A	230 V		30.070.186	130	8
BI225-10	25 A	24 V		30.070.187	130	8
BI232-10	32 A	230 V		30.070.057	130	8
BI232-10	32 A	24 V		30.070.188	130	8



cos φ = 0.6 acc. to IEC/EN 60669-2-2 (4-pole, 2 modules)

AC

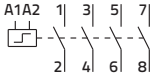
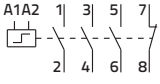
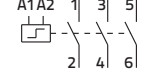
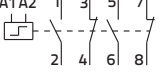
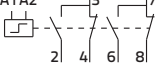
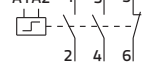
Type	Rated current I _n	Control voltage at 50 Hz	Wiring diagram	Ordering No.	Weight (g)	Packaging (pcs)
BI420-40	20 A	230 V		30.070.026	195	4
BI420-40	20 A	24 V		30.070.189	195	4
BI425-40	25 A	230 V		30.070.060	195	4
BI425-40	25 A	24 V		30.070.190	195	4
BI432-40	32 A	230 V		30.070.027	195	4
BI432-40	32 A	24 V		30.070.072	195	4
BI420-31	20 A	230 V		30.070.031	195	4
BI420-31	20 A	24 V		30.070.191	195	4
BI425-31	25 A	230 V		30.070.192	195	4
BI425-31	25 A	24 V		30.070.193	195	4
BI432-31	32 A	230 V		30.070.033	195	4
BI432-31	32 A	24 V		30.070.194	195	4
BI420-30	20 A	230 V		30.070.195	185	4
BI420-30	20 A	24 V		30.070.196	185	4
BI425-30	25 A	230 V		30.070.197	185	4
BI425-30	25 A	24 V		30.070.198	185	4
BI432-30	32 A	230 V		30.070.199	185	4
BI432-30	32 A	24 V		30.070.200	185	4
BI420-22	20 A	230 V		30.070.030	195	4
BI420-22	20 A	24 V		30.070.065	195	4
BI425-22	25 A	230 V		30.070.201	195	4
BI425-22	25 A	24 V		30.070.202	195	4
BI432-22	32 A	230 V		30.070.032	195	4
BI432-22	32 A	24 V		30.070.055	195	4
BI420-2C	20 A	230 V		30.070.203	185	4
BI420-2C	20 A	24 V		30.070.204	185	4
BI425-2C	25 A	230 V		30.070.205	185	4
BI425-2C	25 A	24 V		30.070.206	185	4
BI432-2C	32 A	230 V		30.070.066	185	4
BI432-2C	32 A	24 V		30.070.067	185	4
BI420-21	20 A	230 V		30.070.207	185	4
BI420-21	20 A	24 V		30.070.208	185	4
BI425-21	25 A	230 V		30.070.165	185	4
BI425-21	25 A	24 V		30.070.209	185	4
BI432-21	32 A	230 V		30.070.210	185	4
BI432-21	32 A	24 V		30.070.211	185	4



Bistable Switches

up to 32 A

cos φ = 0.6 acc. to IEC/EN 60669-2-2 (2-pole, 1 module)

DC

Type	Rated current I _n	Control voltage	Wiring diagram	Ordering No.	Weight (g)	Packaging (pcs)
BI216-20	16 A	24 V		30.070.283	135	8
BI220-20	20 A	24 V		30.070.212	135	8
BI225-20	25 A	24 V		30.070.213	135	8
BI232-20	32 A	24 V		30.070.214	135	8
BI216-11	16 A	24 V		30.070.282	135	8
BI220-11	20 A	24 V		30.070.174	135	8
BI225-11	25 A	24 V		30.070.215	135	8
BI232-11	32 A	24 V		30.070.216	135	8
BI216-1C	16 A	24 V		30.070.281	130	8
BI220-1C	20 A	24 V		30.070.217	130	8
BI225-1C	25 A	24 V		30.070.218	130	8
BI232-1C	32 A	24 V		30.070.219	130	8
BI216-10	16 A	24 V		30.070.280	125	8
BI220-10	20 A	24 V		30.070.152	125	8
BI225-10	25 A	24 V		30.070.220	125	8
BI232-10	32 A	24 V		30.070.221	125	8



BI8xx are special versions of bistable switches with 8 poles for applications where requires a large numbers of mechanical connected contacts.





cos φ = 0.6 acc. to IEC/EN 60669-2-2 (8-pole, 4 modules)

AC

Type	Rated current I _n	Control voltage at 50 Hz	Wiring diagram	Ordering No.	Weight (g)	Packaging (pcs)
BI820-80	20 A	230 V				

AC-1 acc. to IEC/EN 60947-4-1 (2-pole, 2 modules)







AC

Type	Rated current I _e	Control voltage at 50 Hz	Wiring diagram	Ordering No.	Weight (g)	Packaging (pcs)
BI240-20	40 A	230 V		30.075.003	265	4
BI240-20	40 A	24 V		30.075.004	265	4
BI263-20	63 A	230 V		30.075.005	265	4
BI263-20	63 A	24 V		30.075.006	265	4
BI280-20	80 A	230 V		30.075.007	265	4
BI240-11	40 A	230 V		30.075.008	265	4
BI240-11	40 A	24 V		30.075.009	265	4
BI263-11	63 A	230 V		30.075.010	265	4
BI263-11	63 A	24 V		30.075.011	265	4
BI280-11	80 A	230 V		30.075.012	265	4
BI240-1C	40 A	230 V		30.075.013	250	4
BI240-1C	40 A	24 V		30.075.014	250	4
BI263-1C	63 A	230 V		30.075.015	250	4
BI263-1C	63 A	24 V		30.075.016	250	4
BI280-1C	80 A	230 V		30.075.017	250	4
BI240-10	40 A	230 V		30.075.018	240	4
BI240-10	40 A	24 V		30.075.019	240	4
BI263-10	63 A	230 V		30.075.020	240	4
BI263-10	63 A	24 V		30.075.021	240	4
BI280-10	80 A	230 V		30.075.022	240	4



AC-1 acc. to IEC/EN 60947-4-1 (4-pole, 4 modules)

AC

Type	Rated current I _e	Control voltage at 50 Hz	Wiring diagram	Ordering No.	Weight (g)	Packaging (pcs)
BI440-40	40 A	230 V		30.075.023	400	2
BI440-40	40 A	24 V		30.075.024	400	2
BI463-40	63 A	230 V		30.075.025	400	2
BI463-40	63 A	24 V		30.075.026	400	2
BI480-40	80 A	230 V		30.075.027	400	2
BI440-31	40 A	230 V		30.075.028	400	2
BI440-31	40 A	24 V		30.075.029	400	2
BI463-31	63 A	230 V		30.075.030	400	2
BI463-11	63 A	24 V		30.075.031	400	2
BI480-31	80 A	230 V		30.075.032	400	2
BI440-30	40 A	230 V		30.075.033	375	2
BI440-30	40 A	24 V		30.075.034	375	2
BI463-30	63 A	230 V		30.075.035	375	2
BI463-30	63 A	24 V		30.075.036	375	2
BI480-30	80 A	230 V		30.075.037	375	2
BI440-22	40 A	230 V		30.075.038	400	2
BI440-22	40 A	24 V		30.075.039	400	2
BI463-22	63 A	230 V		30.075.040	400	2
BI463-22	63 A	24 V		30.075.041	400	2
BI480-22	80 A	230 V		30.075.042	400	2
BI440-2C	40 A	230 V		30.075.043	385	2
BI440-2C	40 A	24 V		30.075.044	385	2
BI463-2C	63 A	230 V		30.075.045	385	2
BI463-2C	63 A	24 V		30.075.046	385	2
BI480-2C	80 A	230 V		30.075.047	385	2
BI440-21	40 A	230 V		30.075.048	385	2
BI440-21	40 A	24 V		30.075.049	385	2
BI463-21	63 A	230 V		30.075.050	385	2
BI463-21	63 A	24 V		30.075.051	385	2
BI480-21	80 A	230 V		30.075.052	385	2



Bistable Switches Extended with a Communications BICOM



Bistable switches with a communications Can, Modbus, I/O and M-bus are special versions for use in smart buildings, smart installations, demand-side-management and industry solutions. They have four separated contacts for loads up to 32 A.

ISO 11898 CAN compatible standard interface

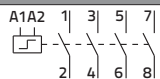
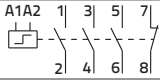
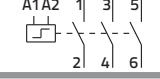
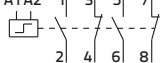
Type	Rated current I _e	Control voltage at 50 Hz	Wiring diagram	Ordering No.	Weight (g)	Packaging (pcs)
BICOM420-40-CAN	20 A	230 V		30.074.001	250	2
BICOM425-40-CAN	25 A	230 V		30.074.002	250	2
BICOM432-40-CAN	32 A	230 V		30.074.003	250	2
BICOM420-31-CAN	20 A	230 V		30.074.004	250	2
BICOM425-31-CAN	25 A	230 V		30.074.005	250	2
BICOM432-31-CAN	32 A	230 V		30.074.006	250	2
BICOM420-30-CAN	20 A	230 V		30.074.007	250	2
BICOM425-30-CAN	25 A	230 V		30.074.008	250	2
BICOM432-30-CAN	32 A	230 V		30.074.009	250	2
BICOM420-22-CAN	20 A	230 V		30.074.010	250	2
BICOM425-22-CAN	25 A	230 V		30.074.011	250	2
BICOM432-22-CAN	32 A	230 V		30.074.012	250	2

AC



Modbus-RTU high-speed RS-485 communication

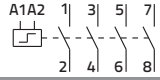
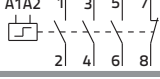
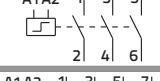
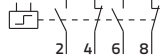

Type	Rated current I _e	Control voltage at 50 Hz	Wiring diagram	Ordering No.	Weight (g)	Packaging (pcs)
BICOM420-40-MODBUS	20 A	230 V		30.074.013	250	2
BICOM425-40-MODBUS	25 A	230 V		30.074.014	250	2
BICOM432-40-MODBUS	32 A	230 V		30.074.015	250	2
BICOM420-31-MODBUS	20 A	230 V		30.074.016	250	2
BICOM425-31-MODBUS	25 A	230 V		30.074.017	250	2
BICOM432-31-MODBUS	32 A	230 V		30.074.018	250	2
BICOM420-30-MODBUS	20 A	230 V		30.074.019	250	2
BICOM425-30-MODBUS	25 A	230 V		30.074.020	250	2
BICOM432-30-MODBUS	32 A	230 V		30.074.021	250	2
BICOM420-22-MODBUS	20 A	230 V		30.074.022	250	2
BICOM425-22-MODBUS	25 A	230 V		30.074.023	250	2
BICOM432-22-MODBUS	32 A	230 V		30.074.024	250	2

AC

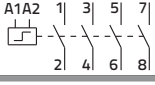

Standard I/O communication

AC

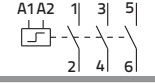
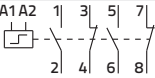
Type	Rated current I _n	Control voltage at 50 Hz	Wiring diagram	Ordering No.	Weight (g)	Packaging (pcs)
BICOM420-40-I/O	20 A	230 V		30.074.025	250	2
BICOM425-40-I/O	25 A	230 V		30.074.026	250	2
BICOM432-40-I/O	32 A	230 V		30.074.027	250	2
BICOM420-31-I/O	20 A	230 V		30.074.028	250	2
BICOM425-31-I/O	25 A	230 V		30.074.029	250	2
BICOM432-31-I/O	32 A	230 V		30.074.030	250	2
BICOM420-30-I/O	20 A	230 V		30.074.031	250	2
BICOM425-30-I/O	25 A	230 V		30.074.032	250	2
BICOM432-30-I/O	32 A	230 V		30.074.033	250	2
BICOM420-22-I/O	20 A	230 V		30.074.034	250	2
BICOM425-22-I/O	25 A	230 V		30.074.035	250	2
BICOM432-22-I/O	32 A	230 V		30.074.036	250	2



Bistable Switches Accessories

Sealing cover for bistable switches up to 32 A

Type	Ordering No.	Weight (g)	Packaging (pcs)
BI32-PP	37.425.439	4	2











Sealing cover for bistable switches up to 80 A

Type	Ordering No.	Weight (g)	Packaging (pcs)
BI80-PP	37.425.484	4	2



Auxiliary switch

AC-15 acc. to IEC/EN 60947-5-1 (2-pole, ½ module)

Type	Rated current I _e	Rated voltage U _e	Wiring diagram			Ordering No.	Weight (g)	Packaging (pcs)
			-20	-11	-1C			
BIN20	4 A	250 V				38.070.012	30	1
BIN11	4 A	250 V				38.070.013	30	1
BIN1C	4 A	250 V				38.070.014	30	1



Auxiliary device for centralised control (½ module)

Type	Ordering No.	Weight (g)	Packaging (pcs)
BIC	38.070.010	30	1



Auxiliary device for group control (½ module)

Type	Ordering No.	Weight (g)	Packaging (pcs)
BIG	38.070.011	30	1



Compensation capacitor

Type	Ordering No.	Weight (g)	Packaging (pcs)
BIK	38.070.009	17	1



4-phase busbars for installation contactors up to 32 A - insulated

Type	Module width	Length (mm)	Ordering No.	Weight (g)	Packaging (pcs)
L/32-8P	4	66	38.046.061	60	10
L/32-12P	6	98	38.046.062	86	
L/32-16P	8	138	38.046.063	114	
L/32-20P	10	173	38.046.064	141	
L/32-24P	12	208	38.046.065	169	

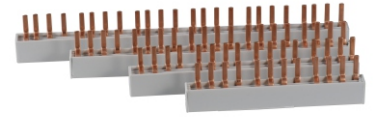

Single pin terminals for installation contactors up to 32 A - insulated

Type	Pin length	Cross-section rigid/flexible (mm ²)	Screw	Ordering No.	Weight (g)	Packaging (pcs)
S/32-1P	13.5/32 (total)	6-25/4-16	PZ2	38.046.066	12	25

Double pin terminals for installation contactors 40 -63 A - insulated terminals for parallel connection

Type	Pin length	Cross-section rigid/flexible (mm ²)	Screw	Ordering No.	Weight (g)	Packaging (pcs)
S/63-2P	15	6-50/4-35	PZ2	38.046.067	22	25



Technical characteristics

Dimensions

TECHNICAL DATA

Type	Symbol	Unit	BI216	BI220	BI225	BI232
Standards			IEC/EN 60669-2-2			
Approvals			CE	CE, CB		
Module width			1			
Number of poles			2			
Degree of protection			IP20			
Pollution degree			3			
Climatic conditions			95 % relative humidity			
Ambient temperature (open)		°C	-25 ... +55 (>55 ... +70 at max. impulse duration which is 1 min)			
Storage temperature		°C	-30 ... +80			
Maximum altitude		m	2000			
U _i and U _e is reduced for 1.2 % and I _e for 0.4 % for every additional 100 m						
Number of contactors or switches side-by-side:			no limitation			
<40 °C			AC: no limitation / DC: max. 3			
(40 ... 55) °C			AC: max. 3 / DC: 0			
(55 ... 70) °C			0 (coil voltage is switched off)			
Noise level (operation)		dB	3 (Z axis)			
Vibration resistance according to IEC/EN 60068-2-6	a	g	15 (Z axis)			
Shock resistance according to IEC/EN 6068-2-27	a	g	900			
Maximum operating frequency with no load		op./h	900		450	
Mechanical endurance		op. c.	1.000.000			
Weight		g	135			
Contact reliability			≥10 V; ≥100 mA			
Minimum distance of open contacts		mm	>3			
Power dissipation per pole		W	1	1.5	2	3
Overload current withstand capability: 10 s		A	48	56	64	80
Maximum back-up fuse for short-circuit protection gL and gG: coordination type 1	I _v	A	16	20	25	32
Rated insulation voltage	U _i	V	440			
Rated impulse withstand voltage	U _{imp}	kV	4			
Rated operational voltage	U _e	V	440			
Rated frequency	f	Hz	50/60			
Thermal current	I _{th}	A	16	20	25	32
Rated operational current for cosφ = 0.6 acc. to IEC/EN 60669-2-2			16	20	25	32
Maximum operating frequency for cosφ = 0.6 acc. to IEC/EN 60669-2-2		op./h	900		450	
Electrical endurance for cosφ = 0.6 acc. to IEC/EN 60669-2-2		op. c.	100.000			
Rated operational current for AC-1, AC-7a and AC-21	I _e	A	16	20	25	32
Operational power for AC-1, AC-7a and AC-21: single-phase 230 V	P _e	kW	3.5	4.4	5.5	7
Maximum operating frequency for AC-1, AC-7a and AC-21		op./h	600		450	
Electrical endurance for AC-1, AC-7a and AC-21		op. c.	100.000			
Rated operational current for AC-2	I _e	A	8	10	13	16
Operational power for AC-2: single-phase 230 V	P _e	kW	1.2	1.5	2	2.4
Maximum operating frequency for AC-2		op./h	120			
Electrical endurance for AC-2		op. c.	100.000			
Rated operational current for AC-3, AC-7b and AC-23	I _e	A	5	7	8	10
Operational power for AC-3, AC-7b and AC-23: single-phase 230 V	P _e	kW	0.37	0.55	0.75	1.1
Maximum operating frequency for AC-3, AC-7b and AC-23		op./h	600		450	
Electrical endurance for AC-3, AC-7b and AC-23		op. c.	100.000			
Rated operational current for AC-5a (at 230 V)	I _e	A	16			
Maximum operating frequency for AC-5a		op./h	600		450	
Electrical endurance for AC-5a		op. c.	100.000			
Rated operational current for AC-5b (at 230 V)	I _e	A	¹ 10		¹ 10 / ² 12 / ³ 16	
Maximum operating frequency for AC-5b		op./h	600		450	
Electrical endurance for AC-5b		op. c.	¹ 100.000 / ² 60.000 / ³ 20.000			

Bistable Switches

up to 32 A



TECHNICAL DATA

Type	Symbol	Unit	BI216	BI220	BI225	BI232
Rated operational current for AC-6a (at 230 V)	I_e	A	2.8	3	3.6	4.5
Maximum operating frequency for AC-6a		op./h	600		450	
Electrical endurance for AC-6a		op. c.	100.000			
Switching of capacitors AC-6b and AC-7c (at 230 V)	C	μ F	80	100	120	150
Maximum operating frequency for AC-6b and AC-7c		op./h	600		450	
Electrical endurance for AC-6b and AC-7c		op. c.	100.000			
Rated operational current for DC-1 (L/R \leq 1 ms): 1 pole ... 24 V DC/48 V DC/60 V DC/110 V DC/ 220 V DC 2 poles in series ... 24 V DC/48 V DC/60 V DC/110 V DC/ 220 V DC	I_e	A	16/12/8/4/0.4 16/15/14/7/3	20/15/10/5/0.5 20/18/15/8/4	25/20/15/6/0.6 25/25/20/10/5	32/25/20/7/0.7 32/28/22/12/6
Maximum operating frequency for DC-1		op./h	300			
Electrical endurance for DC-1		op. c.	100.000			
Rated operational current for DC-3 (L/R \leq 2 ms): 1 pole ... 24 V DC/48 V DC/60 V DC/110 V DC/ 220 V DC 2 poles in series ... 24 V DC/48 V DC/60 V DC/110 V DC/ 220 V DC	I_e	A	9/4/2/1/0.1 16/9/7/3/0.3	10/5/2/1/0.1 20/10/8/3/0.4	15/8/3/1.1/0.2 25/16/12/4/0.6	18/10/4/1.2/0.3 32/18/14/5/0.8
Maximum operating frequency for DC-3		op./h	300			
Electrical endurance for DC-3		op. c.	100.000			
Rated operational current for DC-5 (L/R \leq 7.5 ms): 1 pole ... 24 V DC/48 V DC/60 V DC/110 V DC/ 220 V DC 2 poles in series ... 24 V DC/48 V DC/60 V DC/110 V DC/ 220 V DC	I_e	A	9/3/1/0.3/0.05 16/7/5/1.5/0.1	10/4/1/0.3/0.05 20/8/6/2/0.2	15/5/2/0.5/0.08 25/15/10/3/0.4	18/6/3/0.8/0.1 32/16/12/4/0.6
Maximum operating frequency for DC-5		op./h	300			
Electrical endurance for DC-5		op. c.	100.000			
Terminal capacity: rigid (solid and stranded) flexible	S	mm ²	1 ... 10 1 ... 10			
Length of removed wire insulation		mm	9			
Screw			M4			
Screw head			PZ2			
Tightening torque		Nm	1.2			
Range of control voltage for switch-on	U_c	%	90 ... 110			
Range of control voltage for drop out	U_c	%	AC: 75 ... 20 / DC: 75 ... 10			
Kind of voltage			AC or DC			
Standard control voltages	U_c	V	AC: 8, 12, 24, 48, 120, 230, 240 / DC: 12, 24, 48, 110, 220			
Frequency of AC control voltage	f	Hz	AC: 50 or 60			
Control mode			remote control with impulse voltage / manual control			
Impulse duration of control voltage: minimum optimum - recommended maximum (only in case of breakdown of control system)			AC: 50 ms / DC: 100 ms AC: 100 ... 500 ms / DC: 150 ... 500 ms AC: 1 hour / DC: 1 minute			
Minimum duration between two impulses of control voltage		ms	AC: 150 / DC: 500			
Surge immunity withstand voltage 1.2/50 μ s acc. to standard IEC/EN 61000-4-5		kV	3			
Coil consumption: switch-on operation		VA/W	AC: 18/13 / DC: 9/9 AC: 9/4 / DC: 9/9			
Delays: make brake		ms	AC: 5 ... 20 / DC: 8 ... 35 AC: 5 ... 20 / DC: 8 ... 35			
Terminal capacity: rigid (solid and stranded) flexible		mm ²	1 ... 4 1 ... 4			
Length of removed wire insulation		mm	7			
Screw			M3			
Screw head			PZ1			
Tightening torque		Nm	0.6			
MTTF - Mean time to failure MTTF = $1/\lambda = B10/(0.1 n_{op})$		h	4.166			
MTTF _d - Mean time to failure dangerous MTTF _d = $1/\lambda_d = B10_d/(0.1 n_{op})$		h	8.333			
B10 - Number of operating cycles until 10 % of devices fail		op. c.	50.000			
B10 _d - Number of operating cycles until 10 % of device dangerous B10 _d = B10/ratio of dangerous failures		op. c.	100.000			
λ - Failure rate $\lambda = (0.1 n_{op})/B10$		1/h	0.00024			
λ_d - Failure rate dangerous $\lambda_d = (0.1 n_{op})/B10_d$		1/h	0.00012			
Ratio of dangerous failures		%	50			
n_{op} - Operating cycles (operating cycles/h)		op. c./h	120			

TECHNICAL DATA

Type	Symbol	Unit	BI420 BI820	BI425 BI825	BI432 BI832
Standards			IEC/EN 60669-2-2		
Approvals			CE, CB		
Module width			BI420: 2/BI820: 4	BI425: 2/BI825: 4	BI432: 2/BI832: 4
Number of poles			BI420: 4/BI820: 8	BI425: 4/BI825: 8	BI432: 4/BI832: 8
Degree of protection			IP20		
Pollution degree			3		
Climatic conditions			95 % relative humidity		
Ambient temperature (open)		°C	-25 ... +55 (>55 ... +70 at max. impulse duration which is 1 min)		
Storage temperature		°C	-30 ... +80		
Maximum altitude		m	2000		
U _i and U _e is reduced for 1.2 % and I _e for 0.4 % for every additional 100 m					
Number of contactors or switches side-by-side:			no limitation		
≤40 °C			max. 3		
(40 ... 55) °C			max. 1		
(55 ... 70) °C					
Noise level (operation)		dB	0 (coil voltage is switched off)		
Vibration resistance according to IEC/EN 60068-2-6	a	g	3 (Z axis)		
Shock resistance according to IEC/EN 6068-2-27	a	g	15 (Z axis)		
Maximum operating frequency with no load		op./h	900	450	
Mechanical endurance		op. c.	1.000.000		
Weight		g	BI4xx: 195/BI8xx: 390		
Contact reliability			≥10 V; ≥100 mA		
Minimum distance of open contacts		mm	>3		
Power dissipation per pole		W	1.5	2	3
Overload current withstand capability: 10 s		A	56	68	96
Maximum back-up fuse for short-circuit protection gL and gG: coordination type 1	I _v	A	20	25	32
Rated insulation voltage	U _i	V	440		
Rated impulse withstand voltage	U _{imp}	kV	4		
Rated operational voltage	U _e	V	440		
Rated frequency	f	Hz	50/60		
Thermal current	I _{th}	A	20	25	32
Rated operational current for cosφ = 0.6 acc. to IEC/EN 60669-2-2			20	25	32
Maximum operating frequency for cosφ = 0.6 acc. to IEC/EN 60669-2-2		op./h	900	450	
Electrical endurance for cosφ = 0.6 acc. to IEC/EN 60669-2-2		op. c.	100.000		
Rated operational current for AC-1, AC-7a and AC-21	I _e	A	20	25	32
Operational power for AC-1, AC-7a and AC-21:					
single-phase 230 V	P _e	kW	4.4	5.5	7
three-phase 230 V			7.6	9.5	12.1
three-phase 400 V			13.2	16.5	21
Maximum operating frequency for AC-1, AC-7a and AC-21		op./h	600	450	
Electrical endurance for AC-1, AC-7a and AC-21		op. c.	100.000		
Rated operational current for AC-2	I _e	A	10	13	16
Operational power for AC-2:					
single-phase 230 V	P _e	kW	1.5	2	2.4
three-phase 230 V			2.6	3.3	4.1
three-phase 400 V			4.5	5.8	7.2
Maximum operating frequency for AC-2		op./h	120		
Electrical endurance for AC-2		op. c.	100.000		
Rated operational current for AC-3, AC-7b and AC-23	I _e	A	7	8.5	12
Operational power for AC-3, AC-7b and AC-23:					
single-phase 230 V	P _e	kW	0.5	0.75	1.1
three-phase 230 V			1.5	2.2	3
three-phase 400 V			3	4	5.5
Maximum operating frequency for AC-3, AC-7b and AC-23		op./h	600	450	
Electrical endurance for AC-3, AC-7b and AC-23		op. c.	100.000		
Rated operational current for AC-5a (at 230 V)	I _e	A	16		
Maximum operating frequency for AC-5a		op./h	600	450	
Electrical endurance for AC-5a		op. c.	100.000		
Rated operational current for AC-5b (at 230 V)	I _e	A	¹⁾ 10	¹⁾ 10 / ²⁾ 12	¹⁾ 10 / ³⁾ 16
Maximum operating frequency for AC-5b		op./h	600	450	
Electrical endurance for AC-5b		op. c.	¹⁾ 100.000 / ²⁾ 60.000 / ³⁾ 20.000		

Bistable Switches

up to 32 A



TECHNICAL DATA

	Type	Symbol	Unit	BI420	BI425	BI432
				BI820	BI825	BI832
MAIN CIRCUIT	Rated operational current for AC-6a (at 230 V)	I_e	A	3	3.6	4.5
	Maximum operating frequency for AC-6a		op./h	600	450	
	Electrical endurance for AC-6a		op. c.	100.000		
	Switching of capacitors AC-6b and AC-7c (at 230 V)	C	μ F	100	120	150
	Maximum operating frequency for AC-6b and AC-7c		op./h	600	450	
	Electrical endurance for AC-6b and AC-7c		op. c.	100.000		
	Rated operational current for DC-1 (L/R \leq 1 ms):					
	1 pole ... 24 V DC/48 V DC/60 V DC/110 V DC/ 220 V DC	I_e	A	20/15/10/5/0.5	25/20/15/6/0.6	32/25/20/7/0.7
	2 poles in series ... 24 V DC/48 V DC/60 V DC/110 V DC/ 220 V DC			20/18/15/8/4	25/25/20/10/5	32/28/22/12/6
	3 poles in series ... 24 V DC/48 V DC/60 V DC/110 V DC/ 220 V DC			20/20/20/18/12	25/25/25/20/15	32/32/28/22/18
	4 poles in series ... 24 V DC/48 V DC/60 V DC/110 V DC/ 220 V DC			20/20/20/20/15	25/25/25/22/18	32/32/32/25/20
	Maximum operating frequency for DC-1		op./h	300		
	Electrical endurance for DC-1		op. c.	100.000		
	Rated operational current for DC-3 (L/R \leq 2 ms):					
	1 pole ... 24 V DC/48 V DC/60 V DC/110 V DC/ 220 V DC	I_e	A	10/5/2/1/0.1	15/8/3/1.1/0.2	18/10/4/1.2/0.3
	2 poles in series ... 24 V DC/48 V DC/60 V DC/110 V DC/ 220 V DC			20/10/8/3/0.4	25/16/12/4/0.6	32/18/14/5/0.8
	3 poles in series ... 24 V DC/48 V DC/60 V DC/110 V DC/ 220 V DC			20/20/18/8/1	25/25/25/15/3	32/30/28/18/4
	4 poles in series ... 24 V DC/48 V DC/60 V DC/110 V DC/ 220 V DC			20/20/20/15/6	25/25/25/20/8	32/32/30/22/10
	Maximum operating frequency for DC-3		op./h	300		
	Electrical endurance for DC-3		op. c.	100.000		
	Rated operational current for DC-5 (L/R \leq 7.5 ms):					
	1 pole ... 24 V DC/48 V DC/60 V DC/110 V DC/ 220 V DC	I_e	A	10/4/1/0.3/0.05	15/5/2/0.5/0.08	18/6/3/0.8/0.1
	2 poles in series ... 24 V DC/48 V DC/60 V DC/110 V DC/ 220 V DC			20/8/6/2/0.2	25/15/10/3/0.4	32/16/12/4/0.6
	3 poles in series ... 24 V DC/48 V DC/60 V DC/110 V DC/ 220 V DC			20/20/18/8/1	25/25/20/12/2	32/28/25/16/3
4 poles in series ... 24 V DC/48 V DC/60 V DC/110 V DC/ 220 V DC	20/20/20/12/3			25/25/25/15/5	32/30/28/18/8	
Maximum operating frequency for DC-5		op./h	300			
Electrical endurance for DC-5		op. c.	100.000			
Terminal capacity:						
rigid (solid and stranded)	S	mm ²	1 ... 10			
flexible			1 ... 10			
Length of removed wire insulation		mm	9			
Screw			M4			
Screw head			PZ2			
Tightening torque		Nm	1.2			
Range of control voltage for switch-on	U_c	%	90 ... 110			
Range of control voltage for drop out	U_c	%	AC: 75 ... 20 / DC: 75 ... 10			
Kind of voltage			AC or DC			
Standard control voltages	U_c	V	AC: 8, 12, 24, 48, 120, 230, 240 / DC: 12, 24, 48, 110, 220			
Frequency of AC control voltage	f	Hz	AC: 50 or 60			
Control mode			remote control with impulse voltage / manual control			
Impulse duration of control voltage:						
minimum			AC: 50 ms / DC: 100 ms			
optimum - recommended			AC: 100 ... 500 ms / DC: 150 ... 500 ms			
maximum (only in case of breakdown of control system)			AC: 1 hour / DC: 1 minute			
Minimum duration between two impulses of control voltage		ms	AC: 150 / DC: 500			
Surge immunity withstand voltage 1.2/50 μ s acc. to standard IEC/EN 61000-4-5		kV	3			
Coil consumption:						
switch-on	VA/W		AC: 18/13 / DC: 9/9			
operation			AC: 9/4 / DC: 9/9			
Delays:						
make	ms		AC: 5 ... 20 / DC: 8 ... 35			
brake			AC: 5 ... 20 / DC: 8 ... 35			
Terminal capacity:						
rigid (solid and stranded)	mm ²		1 ... 4			
flexible			1 ... 4			
Length of removed wire insulation		mm	7			
Screw			M3			
Screw head			PZ1			
Tightening torque		Nm	0.6			

TECHNICAL DATA

Type	Symbol	Unit	BI420	BI425	BI432
			BI820	BI825	BI832
MTTF - Mean time to failure $MTTF = 1/\lambda = B10/(0.1 n_{op})$		h		4.166	
MTTF _d - Mean time to failure dangerous $MTTF_d = 1/\lambda_d = B10_d/(0.1 n_{op})$		h		8.333	
B10 - Number of operating cycles until 10 % of devices fail		op. c.		50.000	
B10 _d - Number of operating cycles until 10 % of device dangerous $B10_d = B10/\text{ratio of dangerous failures}$		op. c.		100.000	
λ - Failure rate $\lambda = (0.1 n_{op})/B10$		1/h		0.00024	
λ_d - Failure rate dangerous $\lambda_d = (0.1 n_{op})/B10_d$		1/h		0.00012	
Ratio of dangerous failures		%		50	
n_{op} - Operating cycles (operating cycles/h)		op. c./h		120	

SAFETY

Mounting positions of accessories

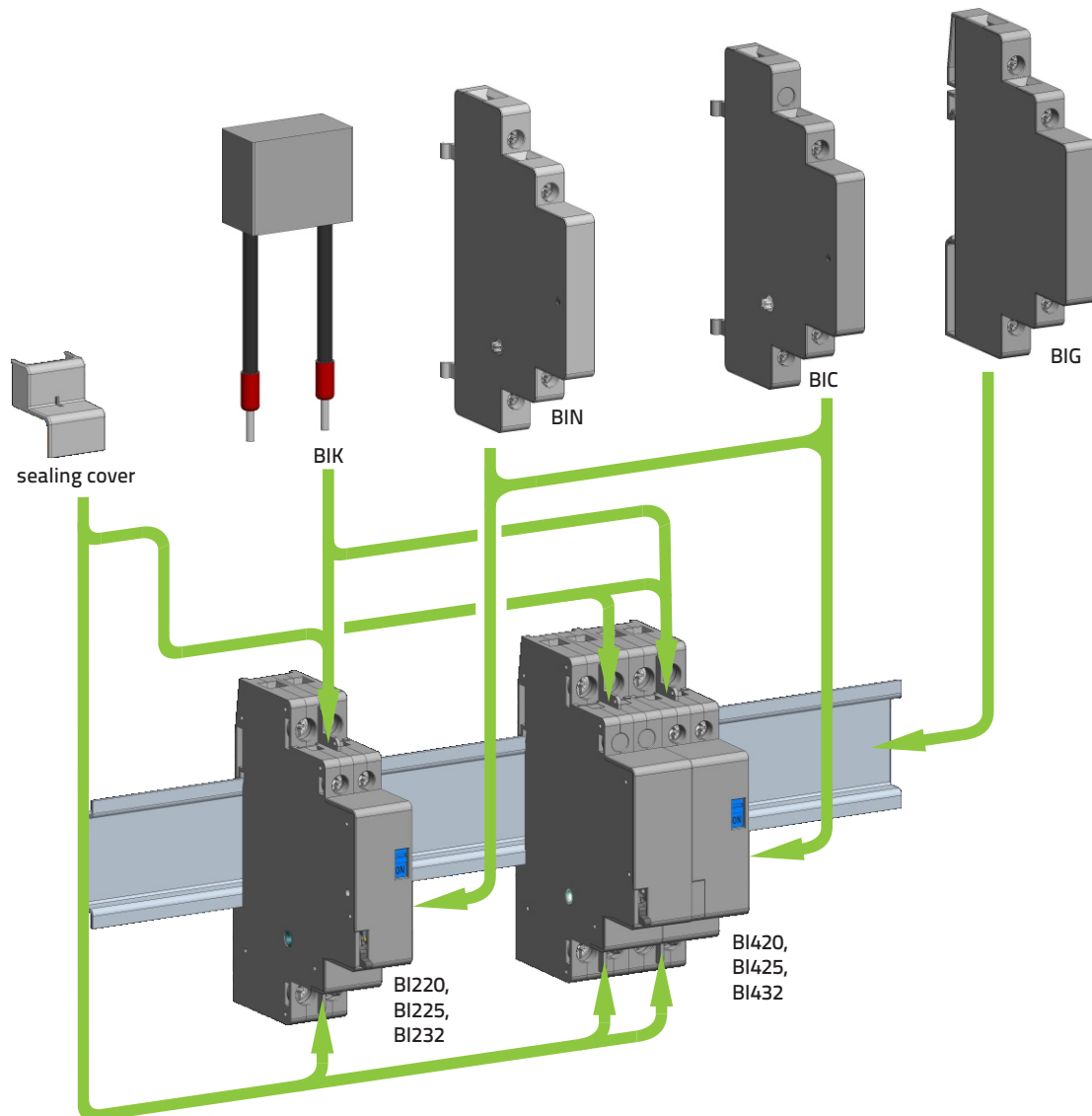

Bistable Switches

up to 80 A



TECHNICAL DATA

Type	Symbol	Unit	BI240	BI263	BI280	BI440	BI463	BI480	
Standards			IEC/EN 61095, IEC/EN 60947-4-1						
Approvals			CE						
Module width			2			4			
Number of poles			2			4			
Degree of protection			IP20						
Pollution degree			3						
Climatic conditions			95 % relative humidity						
Ambient temperature (open)		°C	-25 ... +55 (>55 ... +70 at max. impulse duration which is 1 min)						
Storage temperature		°C	-30...+80						
Maximum altitude		m	2000						
U _i and U _e is reduced for 1.2 % and I _e for 0.4 % for every additional 100 m									
Number of contactors or switches side-by-side:			no limitation						
<40 °C			no limitation		max. 6		no limitation		max. 3
(40 ... 55) °C			max. 4		max. 2		max. 2		max. 1
(55 ... 70) °C									
Noise level (operation)		dB	0 (coil voltage is switched off)						
Vibration resistance according to IEC/EN 60068-2-6	a	g	3 (Z axis)						
Shock resistance according to IEC/EN 6068-2-27	a	g	15 (Z axis)						
Maximum operating frequency with no load		op. c./h	450						
Mechanical endurance		op. c.	1.000.000						
Weight		g	265			400			
Contact reliability			≥10 V; ≥100 mA						
Minimum distance of open contacts		mm	>3						
Power dissipation per pole		W	3	3.5	4	3	3.5	4	
Overload current withstand capability:									
10 s		A	176	240	304	176	240	304	
5 s		A	240	300	350	240	300	350	
1 s		A	300	360	400	300	360	400	
0.001 s		A	500	650	800	500	650	800	
Maximum back-up fuse for short-circuit protection gL and gG: coordination type 1	I _v	A	40	63	80	40	63	80	
Rated insulation voltage	U _i	V	440						
Rated impulse withstand voltage	U _{imp}	kV	4						
Rated operational voltage	U _e	V	400						
Rated frequency	f	Hz	50/60						
Thermal current	I _{th}	A	40	63	80	40	63	80	
Rated operational current for AC-1, AC-7a and AC-21	I _e	A	40	63	80	40	63	80	
Operational power for AC-1, AC-7a and AC-21:									
single-phase 230 V	P _e	kW	8.8	13.8	17.5	8.8	13.8	17.5	
three-phase 230 V						15.1	23.8	30.2	
three-phase 400 V						26.3	41.5	52.5	
Maximum operating frequency for AC-1, AC-7a and AC-21		op. c./h	360						
Electrical endurance for AC-1, AC-7a and AC-21		op. c.	100.000						
Rated operational current for AC-2	I _e	A	25	32	40	25	32	40	
Operational power for AC-2:									
single-phase 230 V	P _e	kW	3.7	4.8	6	3.7	4.8	6	
three-phase 230 V						6.5	8.3	10.3	
three-phase 400 V						11.2	14.4	18	
Maximum operating frequency for AC-2		op. c./h	120						
Electrical endurance for AC-2		op. c.	100.000						
Rated operational current for AC-3, AC-7b and AC-23	I _e	A	22	30	38	22	30	38	
Operational power for AC-3, AC-7b and AC-23:									
single-phase 230 V	P _e	kW	2.2	3.7	4	2.2	3.7	4	
three-phase 230 V						5.5	7.5	11	
three-phase 400 V						11	15	18.5	
Maximum operating frequency for AC-3, AC-7b and AC-23		op. c./h	360						
Electrical endurance for AC-3, AC-7b and AC-23		op. c.	100.000						
Rated operational current for AC-5a (at 230 V)	I _e	A	25	32	36	25	32	36	
Maximum operating frequency for AC-5a		op. c./h	360						
Electrical endurance for AC-5a		op. c.	100.000						
Rated operational current for AC-5b (at 230 V)	I _e	A	25	32	36	25	32	36	
Maximum operating frequency for AC-5b		op. c./h	360						
Electrical endurance for AC-5b		op. c.	100.000						

TECHNICAL DATA

Type	Symbol	Unit	BI240	BI263	BI280	BI440	BI463	BI480
Rated operational current for AC-6a (at 230 V)	I_e	A	10	16	20	10	16	20
Maximum operating frequency for AC-6a		op. c./h	360					
Electrical endurance for AC-6a		op. c.	100.000					
Switching of capacitors AC-6b and AC-7c (at 230 V)	C	μF	220	330	360	220	330	360
Maximum operating frequency for AC-6b and AC-7c		op. c./h	360					
Electrical endurance for AC-6b and AC-7c		op. c.	100.000					
Rated operational current for DC-1 ($L/R \leq 1$ ms): 1 pole ... 24 V DC/48 V DC/60 V DC/110 V DC/ 220 V DC 2 poles in series ... 24 V DC/48 V DC/60 V DC/110 V DC/ 220 V DC 3 poles in series ... 24 V DC/48 V DC/60 V DC/110 V DC/ 220 V DC 4 poles in series ... 24 V DC/48 V DC/60 V DC/110 V DC/ 220 V DC	I_e	A	40/30/25/8/1 40/38/32/14/8	63/35/30/10/1.2 63/42/34/16/10		40/30/25/8/1 40/38/32/14/8	63/35/30/10/1.2 63/42/34/16/10	
Maximum operating frequency for DC-1		op. c./h	300					
Electrical endurance for DC-1		op. c.	100.000					
Rated operational current for DC-3 ($L/R \leq 2$ ms): 1 pole ... 24 V DC/48 V DC/60 V DC/110 V DC/ 220 V DC 2 poles in series ... 24 V DC/48 V DC/60 V DC/110 V DC/ 220 V DC 3 poles in series ... 24 V DC/48 V DC/60 V DC/110 V DC/ 220 V DC 4 poles in series ... 24 V DC/48 V DC/60 V DC/110 V DC/ 220 V DC	I_e	A	22/11/6/1.5/0.4 40/20/16/6/1	25/12/7/2/0.5 45/22/18/7/1.2		22/11/6/1.5/0.4 40/20/16/6/1	25/12/7/2/0.5 45/22/18/7/1.2	
Maximum operating frequency for DC-3		op. c./h	300					
Electrical endurance for DC-3		op. c.	100.000					
Rated operational current for DC-5 ($L/R \leq 7.5$ ms): 1 pole ... 24 V DC/48 V DC/60 V DC/110 V DC/ 220 V DC 2 poles in series ... 24 V DC/48 V DC/60 V DC/110 V DC/ 220 V DC 3 poles in series ... 24 V DC/48 V DC/60 V DC/110 V DC/ 220 V DC 4 poles in series ... 24 V DC/48 V DC/60 V DC/110 V DC/ 220 V DC	I_e	A	25/8/4/1/0.15 40/18/14/5/0.8	30/10/5/1.2/0.2 45/50/15/6/1		25/8/4/1/0.15 40/18/14/5/0.8	30/10/5/1.2/0.2 45/50/15/6/1	
Maximum operating frequency for DC-5		op. c./h	300					
Electrical endurance for DC-5		op. c.	100.000					
Terminal capacity: rigid (solid and stranded) flexible	S	mm^2	2.5 ... 25					
Length of removed wire insulation		mm	11					
Screw			M5					
Screw head			PZ2					
Tightening torque		Nm	2.0					
Range of control voltage for switch-on	U_c	%	85 ... 110					
Range of control voltage for drop out	U_c	%	75 ... 20					
Kind of voltage			AC					
Standard control voltages	U_c	V	8, 12, 24, 48, 120, 230, 240					
Frequency of AC control voltage	f	Hz	50 or 60					
Control mode			remote control with impulse voltage / manual control					
Impulse duration of control voltage: minimum optimum - recommended maximum (only in case of breakdown of control system)			50 ms 100 ... 500 ms 1 hour					
Minimum duration between two impulses of control voltage		ms	150					
Surge immunity withstand voltage 1.2/50 μs acc. to standard IEC/EN 61000-4-5		kV	2					
Coil consumption: switch-on operation		VA/W	26/12 12/4					
Delays: make brake		ms	5 ... 20 5 ... 20					
Terminal capacity: rigid (solid and stranded) flexible		mm^2	1 ... 4 1 ... 4					
Length of removed wire insulation		mm	7					
Screw			M3					
Screw head			PZ1					
Tightening torque		Nm	0.6					

Bistable Switches

up to 80 A

TECHNICAL DATA

Type	Symbol	Unit	BI240	BI263	BI280	BI440	BI463	BI480
MTTF - Mean time to failure $MTTF = 1/\lambda = B10/(0.1 n_{op})$		h				1.388		
MTTF _d - Mean time to failure dangerous $MTTF_d = 1/\lambda_d = B10_d/(0.1 n_{op})$		h				2.777		
B10 - Number of operating cycles until 10 % of devices fail		op. c.				50.000		
B10 _d - Number of operating cycles until 10 % of device dangerous $B10_d = B10/\text{ratio of dangerous failures}$		op. c.				100.000		
λ - Failure rate $\lambda = (0.1 n_{op})/B10$		1/h				0.00072		
λ_d - Failure rate dangerous $\lambda_d = (0.1 n_{op})/B10_d$		1/h				0.00036		
Ratio of dangerous failures		%				50		
n_{op} - Operating cycles (operating cycles/h)		op. c./h				360		

Mounting positions of accessories

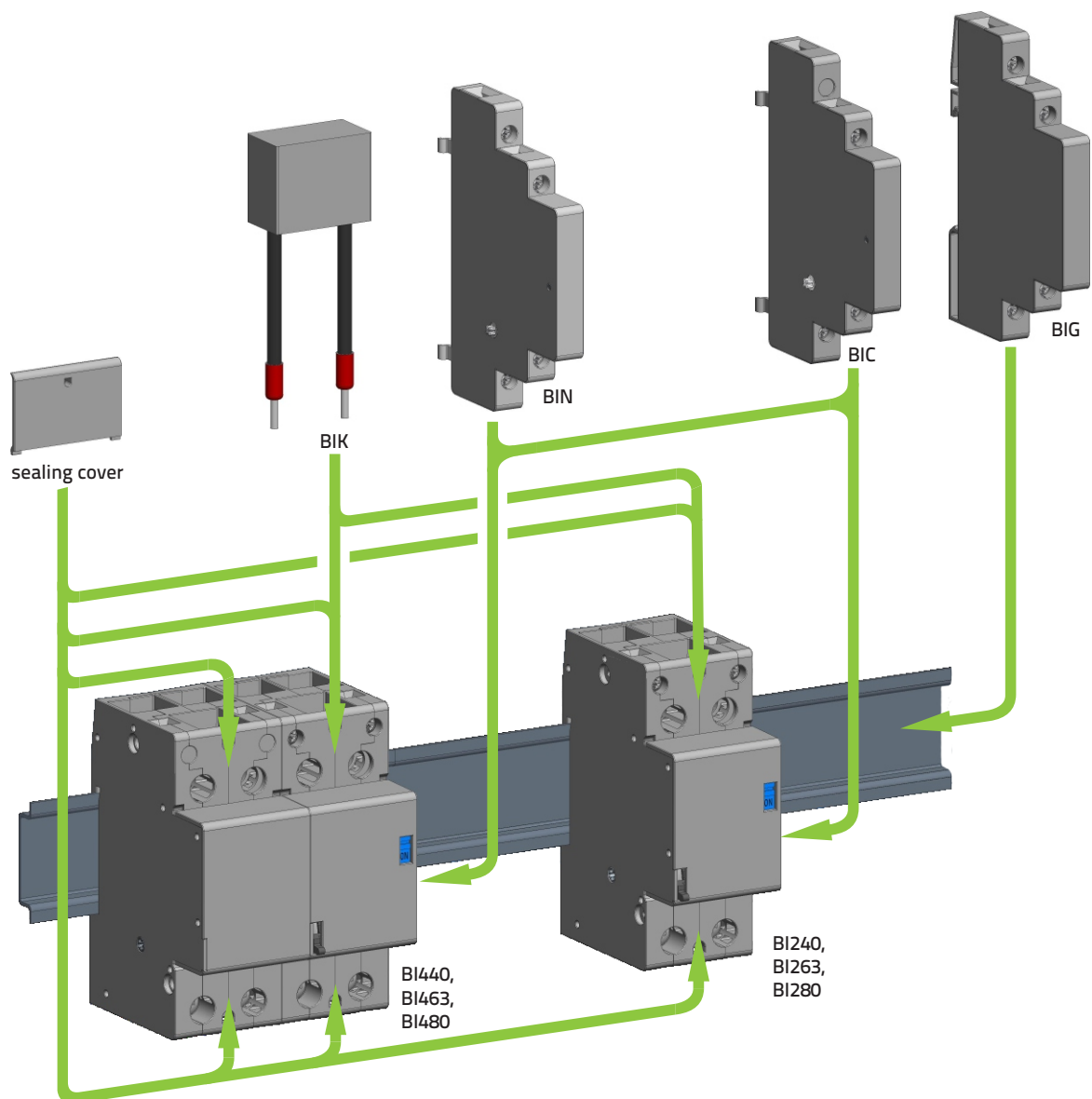

BIN - Auxiliary switch

Benefits

- Reliable switching
- Allows remote indication
- Different versions of contacts
- Compatible with the entire range of bistable switches
- Easy to fit on right side of the bistable switch
- Simple and strong fixing with screw

Wiring diagram

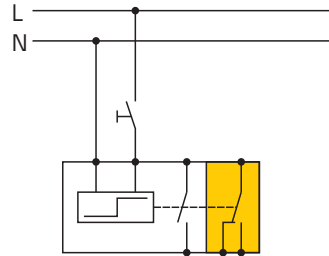

BIC - Auxiliary device for centralised control

Benefits

- For centralised control
- Control by a single command
- Possible to actuate over a time switch
- Each bistable switch with BIC may be independant of local push-button controlled via remote push-buttons ON and OFF
- Compatible with the entire range of bistable switches
- Simple and strong fixing with screw

NOTE: Suitable for AC control systems

Wiring diagram

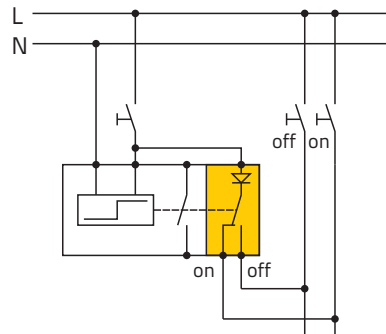

BIG - Auxiliary device for group control

Benefits

- For group control
- Saving space construction
- Quick assambly to 35 mm wide mounting rail

Maximum number of bistable switches that can be controlled:

- 230 V AC: 20
- 120 V AC: 10
- 48 V AC: 5
- 24 V AC: 2
- 12 V AC: 1

NOTE: Suitable for AC control systems

Wiring diagram

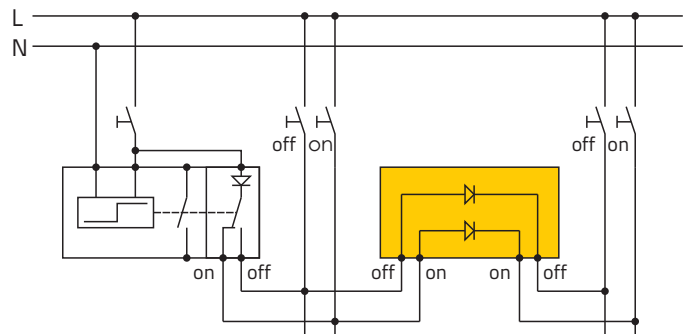

BIK - Compensation capacitor

Benefits

- Increase the number of illuminated push-buttons
- After the installation is not visible from the cabinet
- Independent unit

Use

For operations of bistable switches without malfunctions when illuminated push-buttons are used. Compensation capacitors parallel to the coil of bistable switch increases the powerconsumption of 230 V 50 Hz illuminated push-buttons from 2.5 mA to 20 mA.

Bistable Switches

Accessories



TECHNICAL DATA

	Type	Symbol	Unit	BIN	BIC	BIG
GENERAL	Standards			IEC/EN 60947-5-1		
	Approvals			CE		
	Module width			1/2 (9 mm)		
	Number of poles			2		
	Degree of protection			IP20		
	Pollution degree			3		
	Climatic conditions			95 % relative humidity		
	Ambient temperature (open)		°C	-25 ... +70		
	Storage temperature		°C	-30... +80		
	Maximum altitude		m	2000		
	U _i and U _e is reduced for 1.2 % and I _e for 0.4 % for every additional 100 m					
	Vibration resistance according to IEC/EN 60068-2-6	a	g	3 (Z axis)		
	Shock resistance according to IEC/EN 6068-2-27	a	g	15 (Z axis)		
	Mechanical endurance		op. c.	1.000.000		
Weight		g	30			
AUXILIARY CIRCUIT	Contact reliability			≥12 V; ≥5 mA		
	Minimum distance of open contacts		mm	>3		
	Power dissipation per pole		W	0.3		
	Maximum back-up fuse for short-protection gL and gG: coordination type 1	I _v	A	6		
	Rated insulation voltage	U _i	V	440		
	Rated impulse withstand voltage	U _{imp}	kV	4		
	Rated operational voltage	U _e	V	250		
	Rated frequency	f	Hz	50/60		
	Thermal current	I _{th}	A	6		
	Rated operational current for AC-15: single-phase 230 V	I _e	A	4		
	Maximum operating frequency for AC-15		op. c./h	360		
	Electrical endurance for AC-15		op. c.	100.000		
	Terminal capacity: rigid (solid and stranded)	S	mm ²	1 ... 4		
	flexible			1 ... 4		
Length of removed wire insulation		mm	7			
Screw			M3			
Screw head			PZ1			
Tightening torque		Nm	0.8			
SAFETY	MTTF - Mean time to failure MTTF = 1/λ = B10/(0.1 n _{op})		h	1.388		
	MTTF _d - Mean time to failure dangerous MTTF _d = 1/λ _d = B10 _d /(0.1 n _{op})		h	2.777		
	B10 - Number of operating cycles until 10 % of devices fail		op. c.	50.000		
	B10 _d - Number of operating cycles until 10 % of device dangerous B10 _d = B10/ratio of dangerous failures		op. c.	100.000		
	λ - Failure rate λ = (0.1 n _{op})/B10		1/h	0.00072		
	λ _d - Failure rate dangerous λ _d = (0.1 n _{op})/B10 _d		1/h	0.00036		
	Ratio of dangerous failures		%	50		
	n _{op} - Operating cycles (operating cycles/h)		op. c./h	360		

Operation position

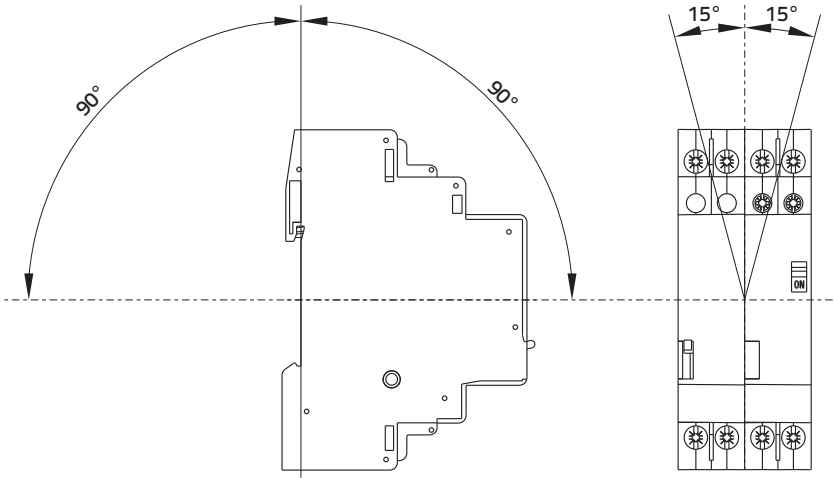

Dimension

BI220, BI225
BI232

BI420, BI425
BI432, BICOM

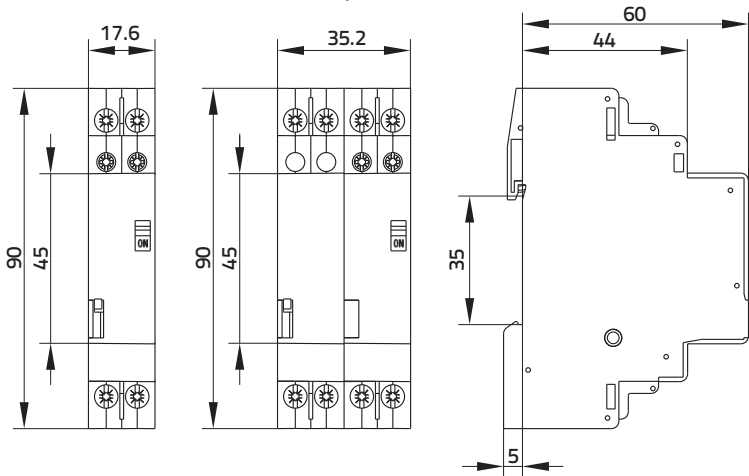

BI240, BI263
BI280

BI440, BI463
BI480

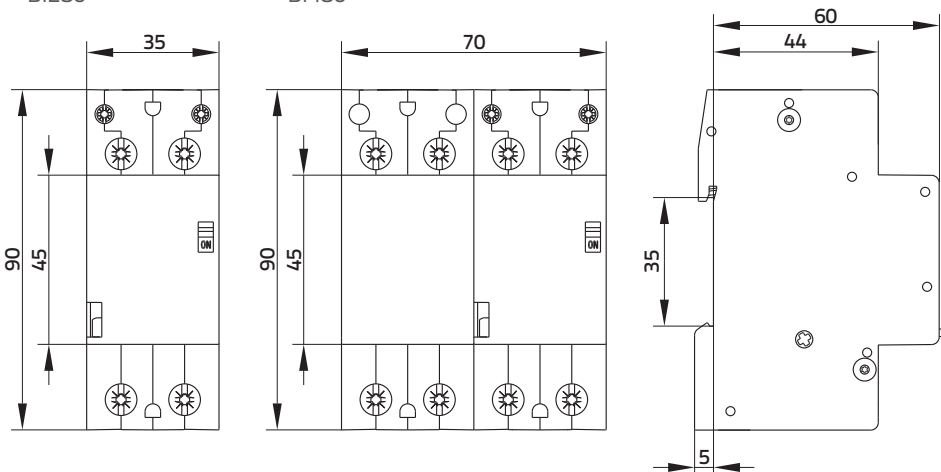

Bistable Switches

Dimensions

Dimensions

BI820, BI825
BI832

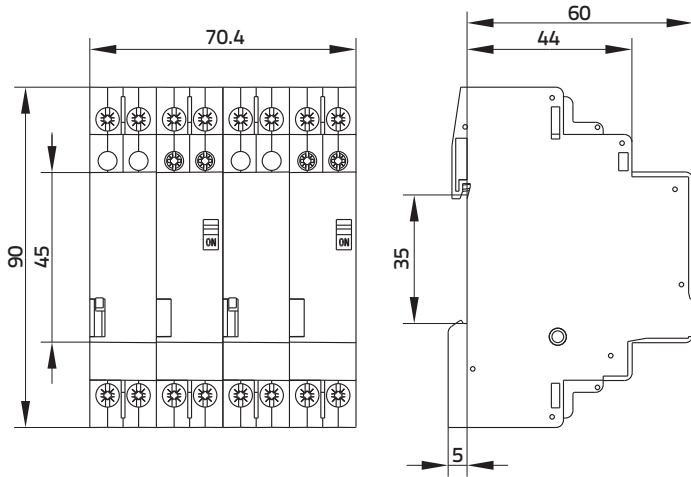

BIN, BIC

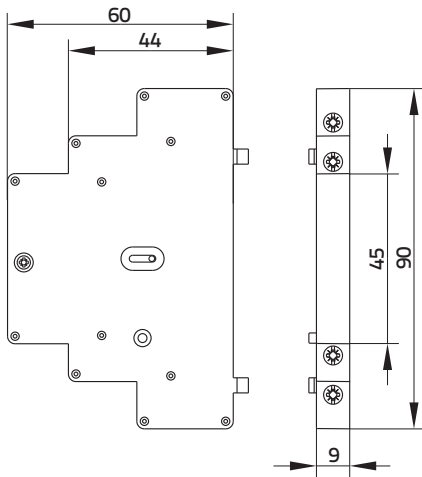

BIG

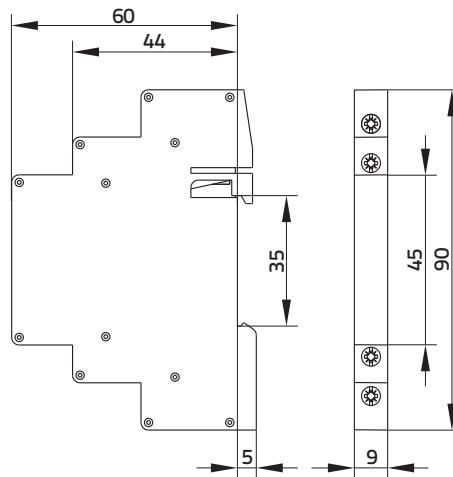

Scheme for connection BIG, BIC and bistable switches in level

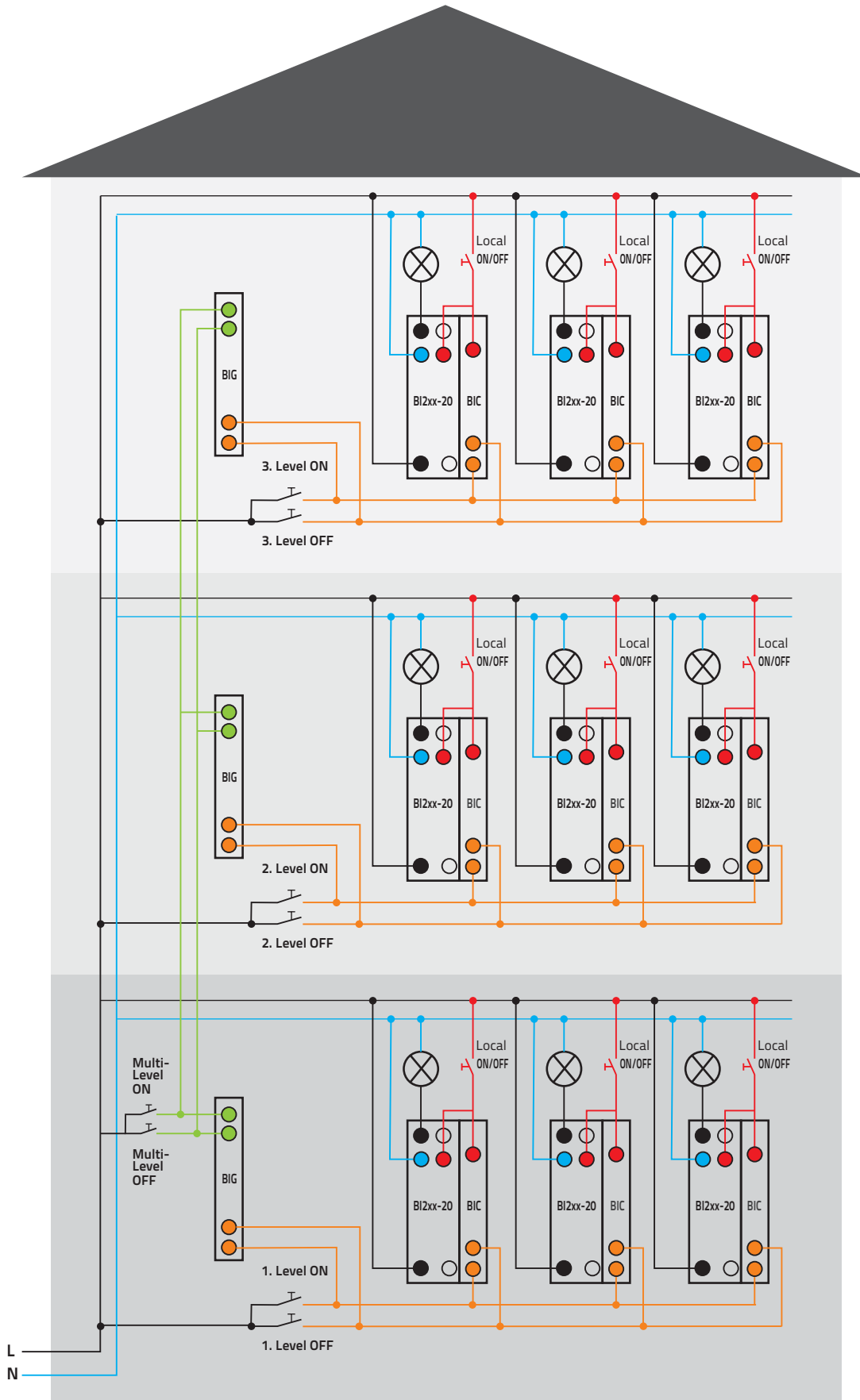

X-ON Electronics

Largest Supplier of Electrical and Electronic Components

Click to view similar products for [General Purpose Relays](#) category:

Click to view products by [Iskra](#) manufacturer:

Other Similar products are found below :

[APF30318](#) [JVN1AF-4.5V-F](#) [PCN-105D3MHZ](#) [5JO-10000S-SIL](#) [5JO-1000CD-SIL](#) [5JO-400CD-SIL](#) [LY2S-AC220/240](#) [LYQ20DC12](#)
[6031007G](#) [6131406HQ](#) [6-1393099-3](#) [6-1393099-8](#) [6-1393122-4](#) [6-1393123-2](#) [6-1393767-1](#) [6-1393843-7](#) [6-1415012-1](#) [6-1419102-2](#) [6-](#)
[1423698-4](#) [6-1608051-6](#) [6-1608067-0](#) [6-1616170-6](#) [6-1616248-2](#) [6-1616282-3](#) [6-1616348-2](#) [6-1616350-1](#) [6-1616350-8](#) [6-1616358-7](#) [6-](#)
[1616359-9](#) [6-1616360-9](#) [6-1616931-6](#) [6-1617039-1](#) [6-1617052-1](#) [6-1617090-2](#) [6-1617090-5](#) [6-1617347-5](#) [6-1617353-3](#) [6-1617801-8](#) [6-](#)
[1617802-2](#) [6-1618107-9](#) [6-1618248-4](#) [M83536/1-027M](#) [CX-4014](#) [MAHC-5494](#) [MAVCD-5419-6](#) [703XCX-120A](#) [7-1393100-5](#) [7-1393111-7](#)
[7-1393144-5](#) [7-1393767-8](#)